









33 800 760



- saillie 220 mm
- bec pivotant 130°
- jet enrichi en air
- hauteur de robinetterie 167 mm
- hauteur jusqu'au mousseur 145 mm
- diamètre de percement 35 mm
- débit d'eau maxi. 8 l/min avec une pression d'écoulement de 3 bars
- sans plomb
- Ce produit contribue au respect des exigences des systèmes d'évaluation des bâtiments écologiques, par exemple LEED®, BREEAM®, DGNB

	Dark Chrome	33 800 760-19
	Chrome	33 800 760-00
	Platine brossé	33 800 760-06
	Platine	33 800 760-08
	Laiton brossé (Or 23cts)	33 800 760-28
	Champagne brossé (Or 22cts)	33 800 760-46
	Champagne (Or 22cts)	33 800 760-47
	Chrome brossé	33 800 760-93
	Dark Platinum brossé	33 800 760-99

Accessoires recommandés

Distributeur sans rosace - Dark Chrome 82 424 970-19



Accessoires recommandés

Commande de vidage individuelle manuelle Commande manuelle - Dark Chrome 10 712 970-19



33 800 760



Diagramme de débit



Certificats

GDV_0400276. LGA_19870.

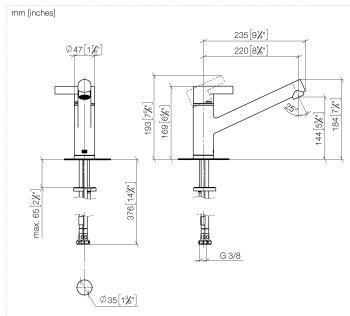
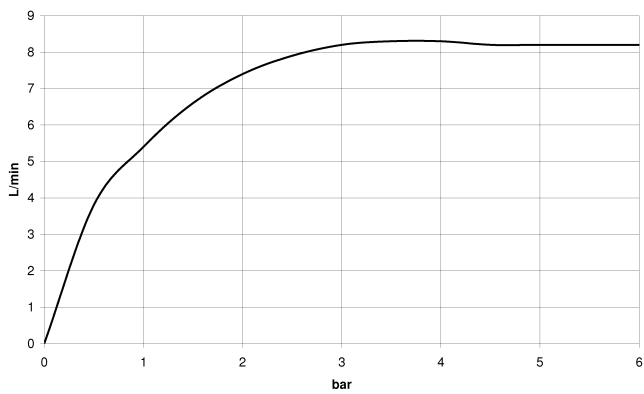
33 800 760

Les pièces pour les autres finitions peuvent être trouvées ici : [Chrome](#)

